

超高真空电极/馈通贯穿件



D-Subminiature Accessories

Ultra High Vacuum D-sub Feedthroughs, Connectors and Accessories

AML生产一系列的D-Sub超高真空配件以补充其超高真空兼容的步进电机。这些配件使得在真空中安装电机和其他多轴运动平台更加容易。

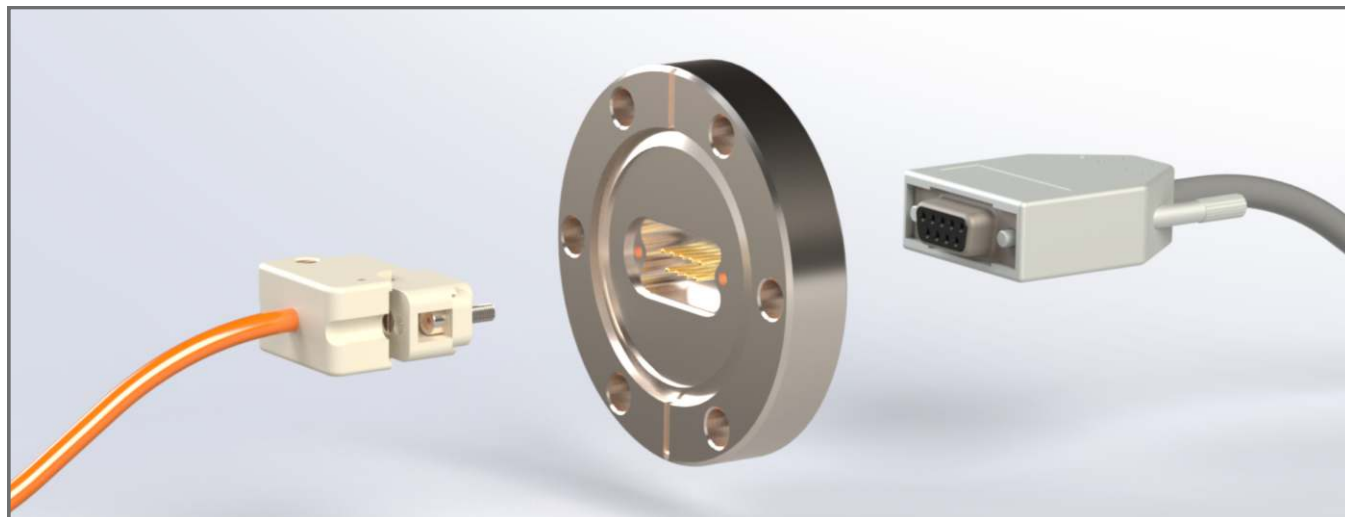

真空贯穿件



VF9D-40CF (真空电极/真空馈通/真空贯穿件)

D-sub-9针真空电极, 尺寸为DN40CF(外径70mm), 单独的玻璃陶瓷压缩密封且烘烤可达250°C, 适用于真空 1.3×10^{-10} mBar, 真空侧和大气侧全部为DB9公头, 1.01mm的镀金引脚, 最大电压500V, 5A/pin (max 20% of pins);



VF15D-63CF (真空电极/真空馈通/真空贯穿件)

D-sub-15针真空电极, 尺寸为DN63CF(外径114mm), 单独的玻璃陶瓷压缩密封且烘烤可达250°C, 适用于真空 1.3×10^{-10} mBar, 真空侧和大气侧全部为DB9公头, 1.01mm的镀金引脚, 最大电压500V, 5A/pin (max 20% of pins);

真空侧连接头



VCxxDF

真空侧可烘烤至250°C的DB接头, DB9路和DB15路母头可与VFxxD-xxCF真空电极配合, 适用于真空 1.3×10^{-10} mBar;

真空侧保护套



VCxxDB

与VCxxDF连接器配套使用, 可烘烤的PEEK材料, 用于保护线缆的拖拽。适用于真空 1.3×10^{-10} mBar;

大气侧连接头



CON-DxxM

与VF9D-40CF和VF15D-63CF配套使用的大气侧9针或15针的连接器;

PINS AND TOOLING



XCRDSUB

D-sub连接器压接工具;

VCDSKT

D-sub金属端子用于接线, 每包10个;

尺寸图

VC9DF

Pin Number Locations

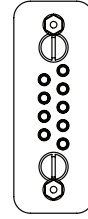
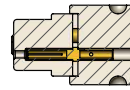
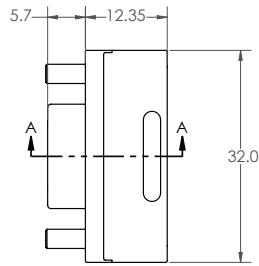
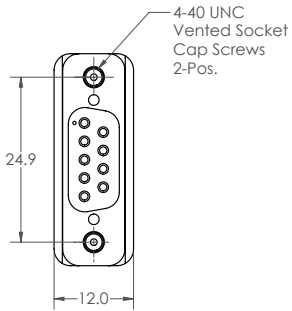
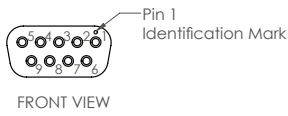

20-24 AWG Machined D-Sub Socket Crimp
P/N 030-1953-000

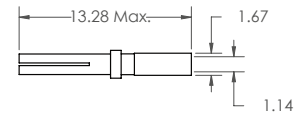

VC15DF

Pin Number Locations

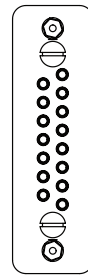
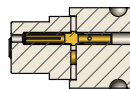
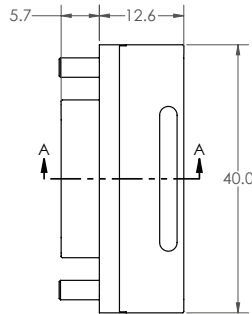
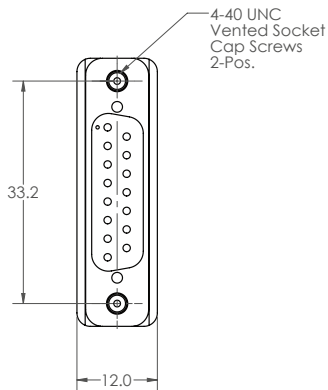
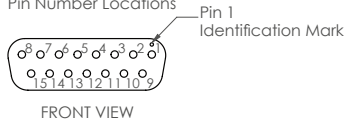

20-24 AWG Machind D-Sub Socket Crimp
P/N 030-1953-000

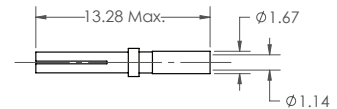

订单信息

Order Code	
VF9D-40CF	D-sub 9-针 真空电极
VF15D-63CF	D-sub 15-针 真空电极
VC9DF	D-sub 9-针 PEEK 连接器
VC15DF	D-sub 15-针 PEEK 连接器
VC9DB	9-针PEEK线缆保护连接器
VC15DB	15-针PEEK线缆保护连
CON-D9M	D-sub 9-针大气侧连接器
CON-D15M	D-sub 15-针大气侧连接器
XCRDSUB	D-sub连接器压接工具
VCDSKT	D-sub金属母头端子. 每包10个

北京星微自动化科技有限公司
Beijing XVAC Automation Technology Co.,Ltd.

电话: +86 010-8953 7435
地址: www.xivimotion.com
邮箱: sales@xivimotion.com

AML pursues a policy of continuous improvement and reserves the right to make detail changes to specifications without consultation. E and OE.